

# JACKOBOARD® Aqua Base

*Base element for JACKOBOARD® Aqua shower unit.*

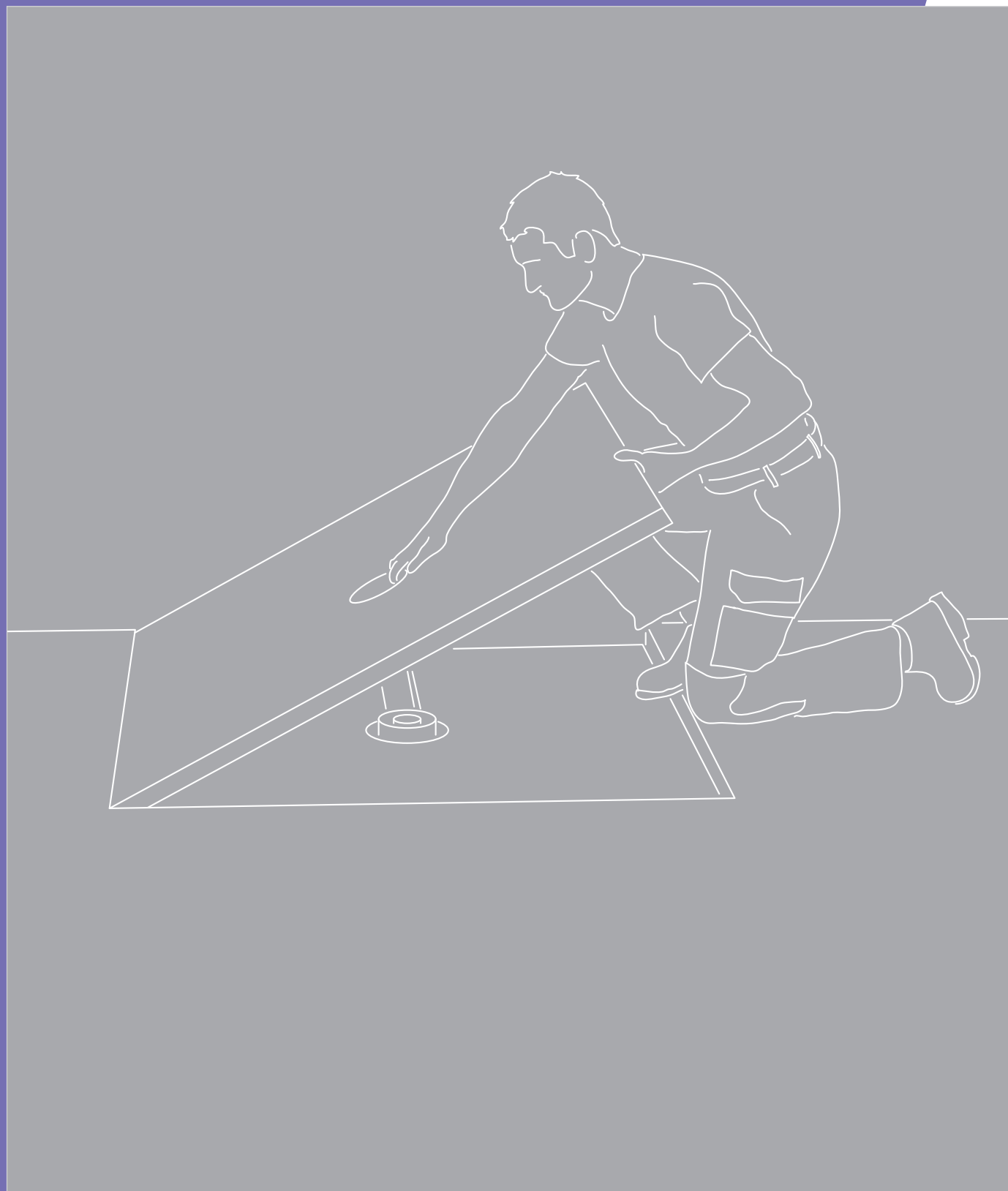

**1)** Provided on site: Screed recess with DN 50 discharge pipe.

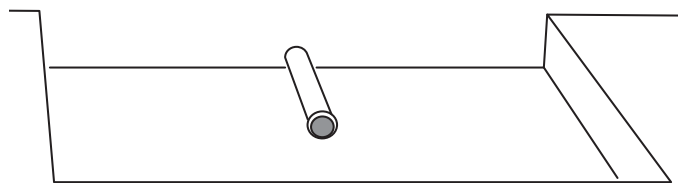

**2)** The base element is trimmed from the edge towards the area of the DN 50 discharge pipe with the help of a saw.

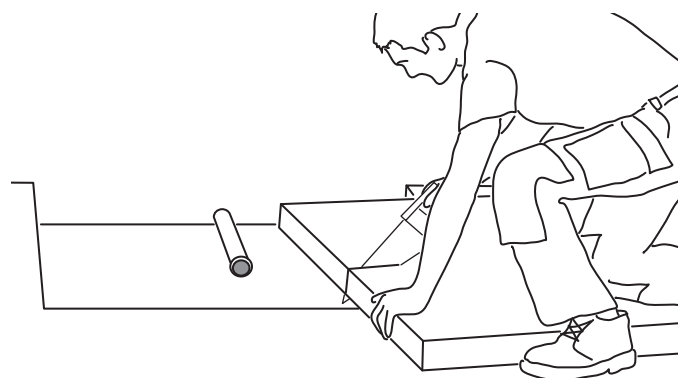

**3)** Cement based single part flexible adhesive is applied to the underside of the base element with a notched trowel.

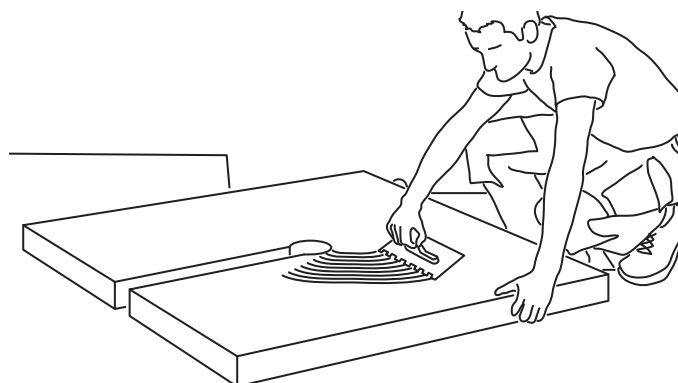

**4)** The base element is then inserted into the screed recess.

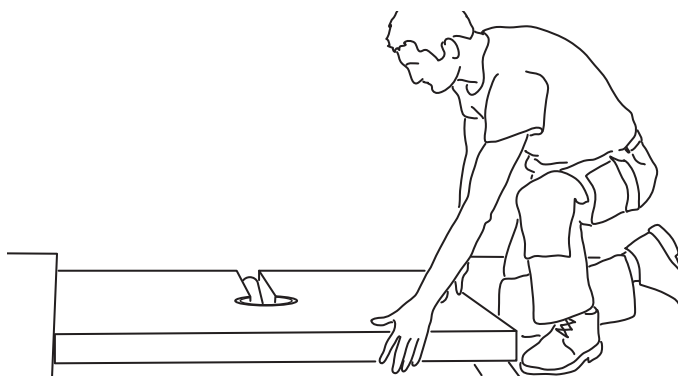

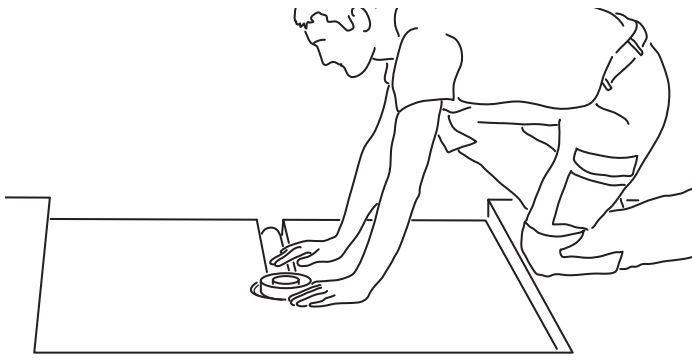

**5)** The base of the floor drain is pushed into the DN 50 discharge pipe...

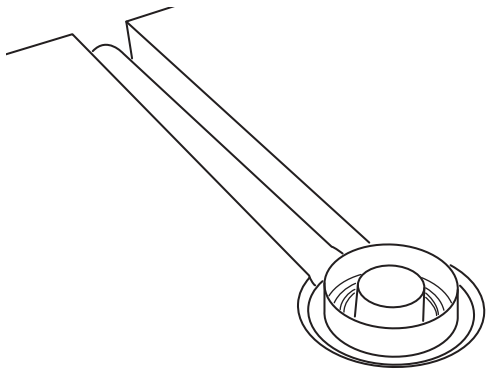

**6)** ...and guided into the cut-out provided on the base element.

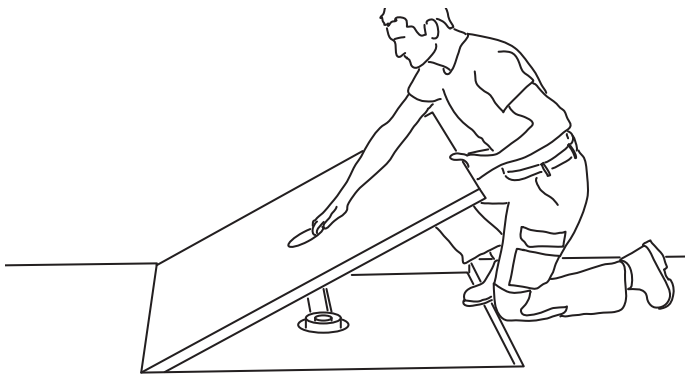

**7)** The shower element is bonded to the base element using cement based single part flexible adhesive using a 5 cm notched trowel applied to the entire surface.

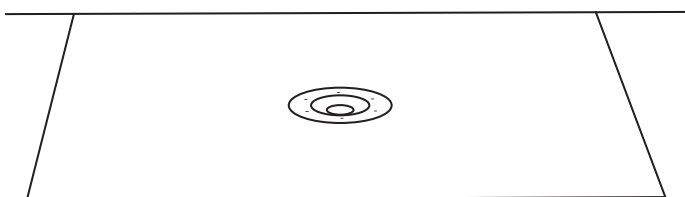

**8)** The shower element is installed at flush level with the screed.

In the case of floor structures with impact sound insulation, the installation of suitable impact sound insulation beneath JACKOBOARD® Aqua Base element and edge insulation strips

must be included in the planning. The exact height can be adjusted using the thickness of the cement-like adhesive (2 – 7 mm).

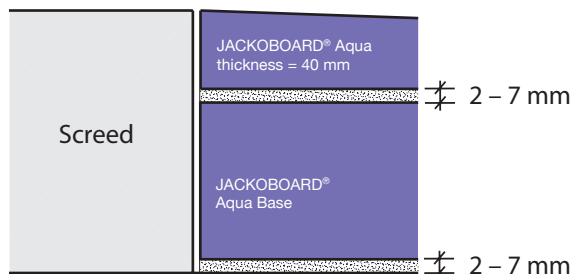

Screed height [mm]	Base element thickness [mm]
64 – 74	20
74 – 84	30
84 – 94	40
94 – 104	50
104 – 114	60
114 – 124	70
124 – 134	80
134 – 144	90

**Note:** The overall height of the shower element is dependent on the drainage system. Please consult the installation notes for JACKOBOARD® Aqua.

**Please note**

The information in this leaflet is based on our experience and current materials specification. It represents no specific guarantee and the instructions for use outlined should be always observed together with considerations regarding building structure and existing Building Law.